

PRODUCT CODE: IT1G
CONDUIT INSPECTION TEE

DESCRIPTION

20mm Conduit Inspection Tee

FINISH

Hot Dipped Galvanised

MATERIAL

Body: Malleable Iron / Cover: Steel

PACKAGING

Packed in qty 10

ADDITIONAL NOTES

Conforms to BS EN61386-1
Compliant to LU Standard 1-085 (for use on surface & sub-surface locations)
Supplied complete with qty 2 M4 x 6mm pozi-pan screws

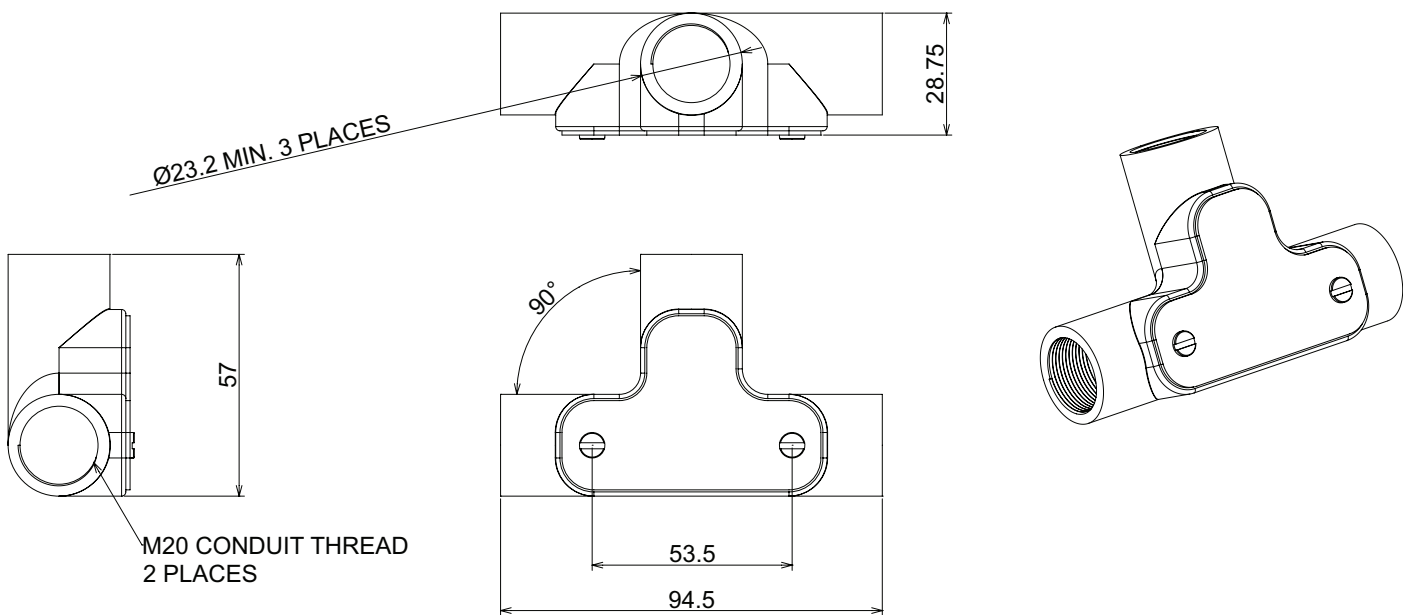
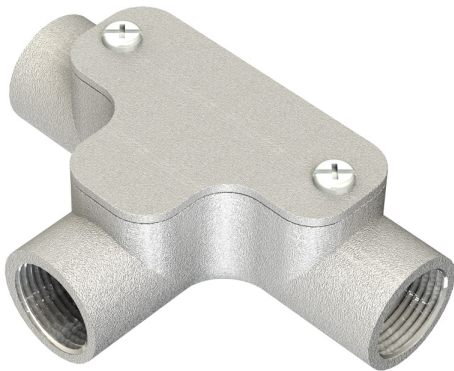

Values are nominal and with a general tolerance $\pm 5\%$ unless otherwise specified